

Category of vehicle

Category	Weight
RS 2D	670 kg 1477 lbs
RS 3D	680 kg 1499 lbs

CAPACITIES AND DIMENSIONS

2. Front track 130.5 cm 51.4 inches
3. Rear track 128.5 cm 50.6 inches
4. Overall length of the car 365 cm
9. Weight, total weight of the car with normal equipment, water, oil and spare wheel but without fuel nor repair tools.  
670 kg 1477 lbs

\*\*\* Width of the car measured in the vertical plane passing through the axle of the wheels.

Front 149.5 cm

ACCESSORIES AND UPHOLSTERY

44. Front bumper, Weight 4.9 kg
45. Rear bumper, Weight 4.9 kg

WHEELS (See right photograph)

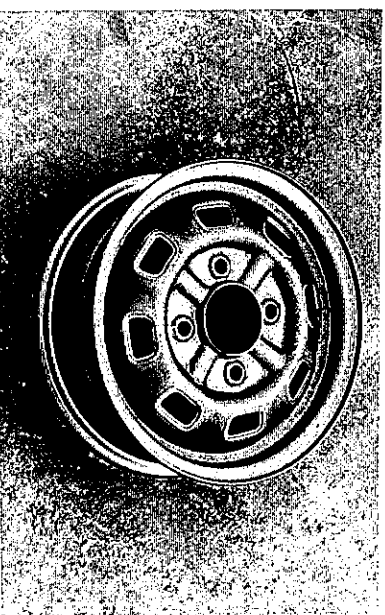

51. Weight (per wheel, without tyre) 7.0 kg
53. Rim Diameter 330 mm 13 inches
54. Rim width 114 mm 4.5 inches

ENGINE

142. Compression ratio 8.6
143. Volume of one combustion chamber 42.7 cm<sup>3</sup>

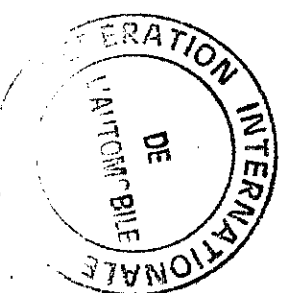

INLET (see page 4)

- 181. Diameter of valves 35 mm 1.38 inches
- 187. Valves open at (with tolerance for tappet clearance indicated) BTDC.  $44^{\circ} \pm 3$
- 188. Valves close at (with tolerance for tappet clearance indicated) ABDC.  $79^{\circ} \pm 3$

EXHAUST (see page 4)

- 196. Diameter of valves 31 mm 1.22 inches
- 202. Valves open at (with tolerance for tappet clearance indicated) BBDC.  $91^{\circ} \pm 3$
- 203. Valves close at (with tolerance for tappet clearance indicated) ATDC.  $46^{\circ} \pm 3$

CARBURETION (photograph N)

- 210. Number of carburetors fitted 2 Side-draft
- 211. Type KEIHIN SEIKI
- 212. Make 743 A
- 213. Model
- 214. Number of mixture passages per carburetor 1
- 215. Flange hole diameter of exit port(s) of carburetor 36 mm
- 216. Minimum dimensions of mixture passage(s) 32 mm

ENGINE AND CAR PERFORMANCES (as declared by manufacturer in catalogue)

- 250. Max. engine output 76 PS (type of horsepower: JIS) at 6,000 rpm
- 251. Maximum rpm 6,500 rpm output at that figure 73 PS
- 252. Maximum torque 10.3 kg.m at 4,000 rpm
- 253. Maximum speed of the car 160 km/hour

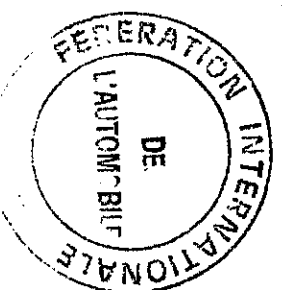

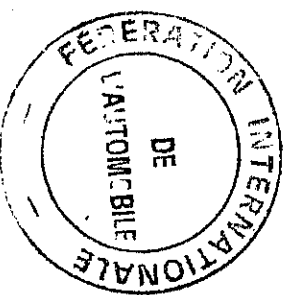
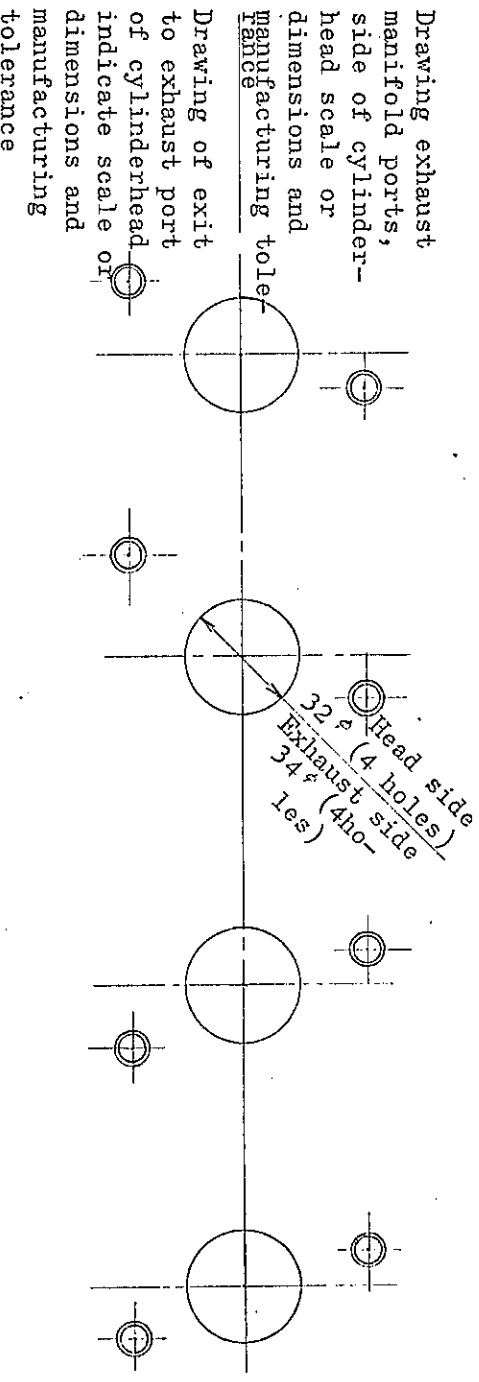
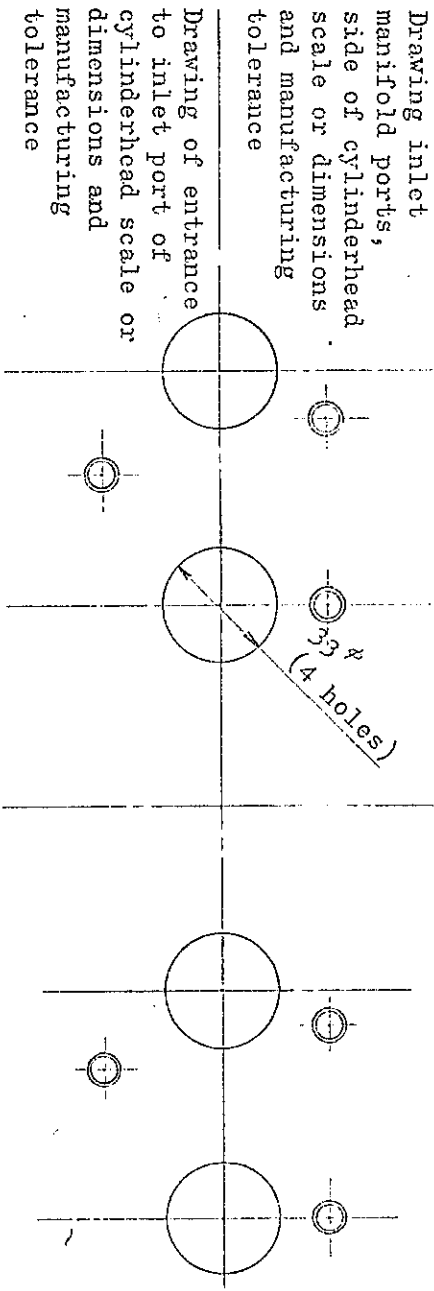

Make HONDA MOTOR CO., LTD.

Model

HONDA SBI

J.A.F. 公認番号 P-211-V2  
F.I.A. Rec. No. 5531

DRIVE TRAIN

GEAR BOX (photograph H)

271. No. of gear-box ratios forward 5  
277.

	Manual	
	Ratio	No. teeth
5 speed	0.71	20/28

FINAL DRIVE

293. Final drive ratio 4.73  
Number of teeth 71/15

Photograph

B.3/4 view of car from rear, RS2D

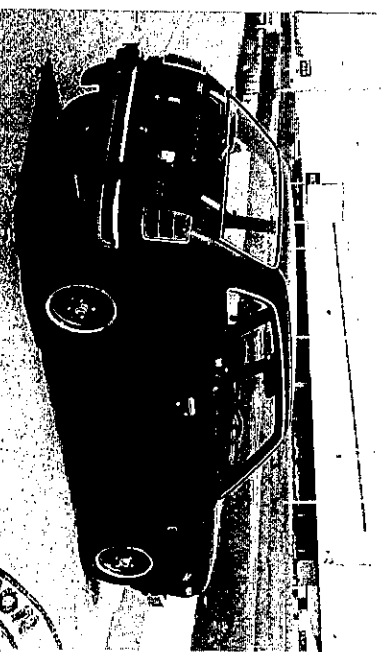

B.3/4 view of car from rear, RS3D

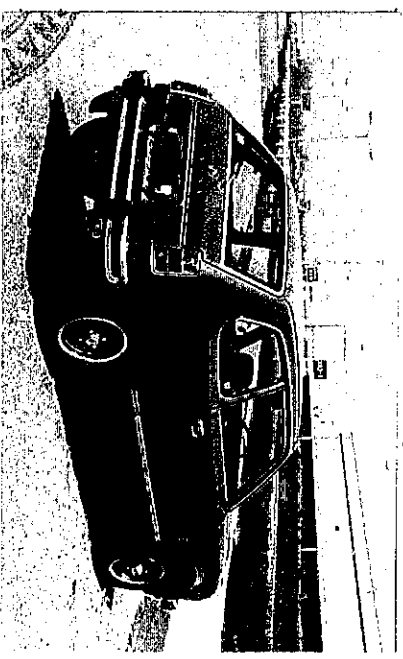

C. Interior view of car through driver's open with dashboard

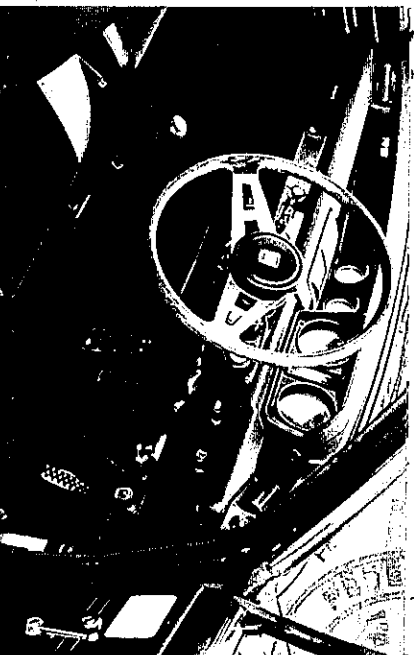

H. Gear-box, view from side

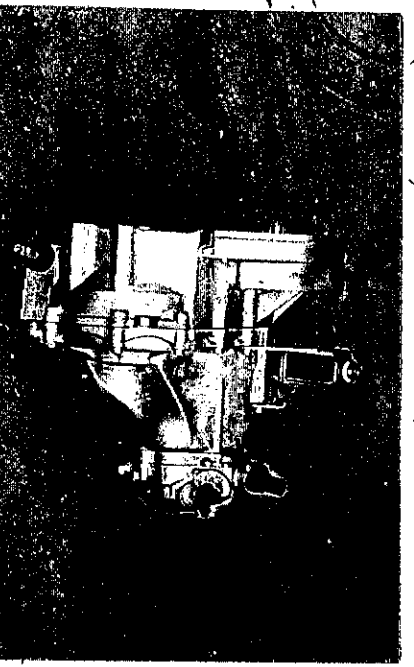

Photograph

I. Silencer + exhaust pipes after exhaust manifold

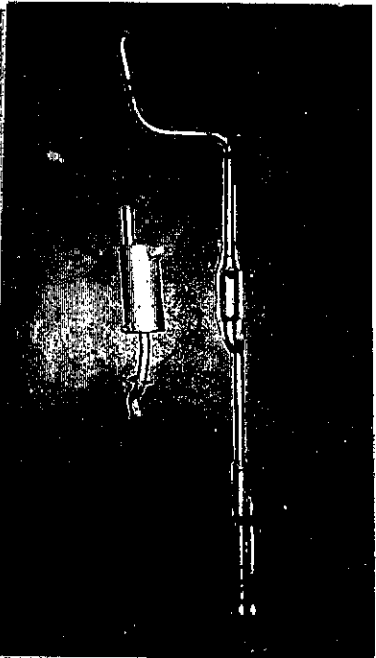

K. Engine unit out of car, from left, with clutch and accessories but without gear-box nor air filter

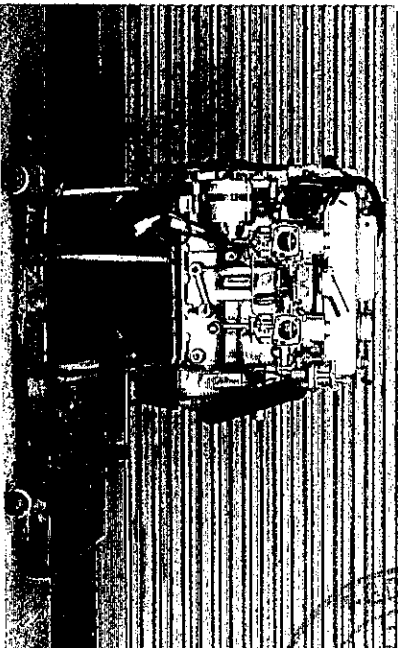

N. Carburetter (view from side of manifold)

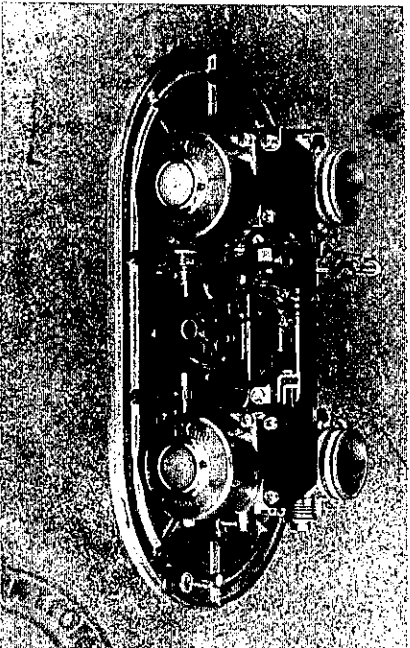

P. Inlet manifold

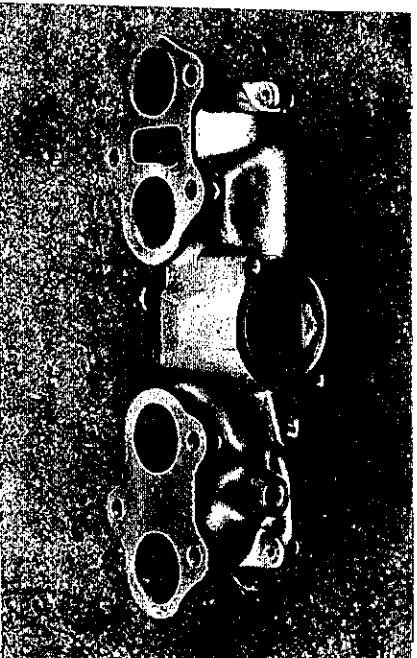

J. Engine unit out of car, from right, with clutch and accessories but without air filter nor gear-box

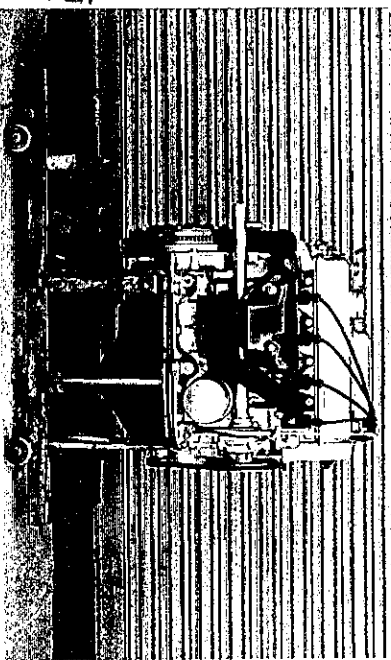

L. Combustion chamber

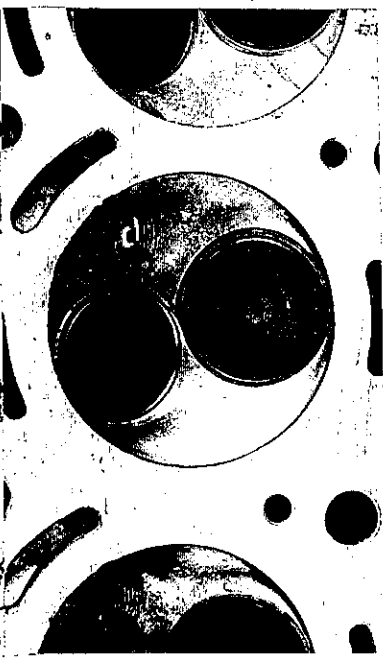

O. Engine in car with all accessories, bonnet open or removed

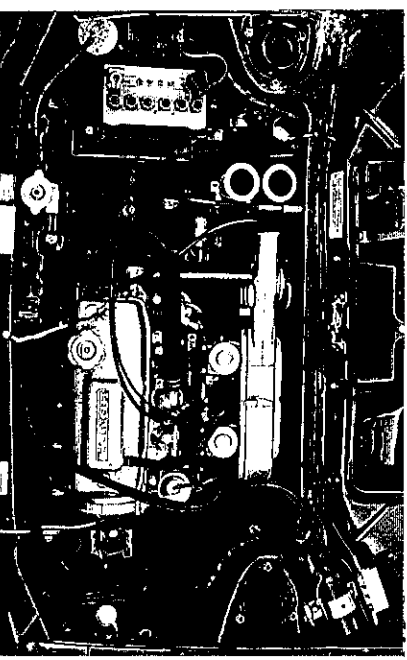

M. Exhaust manifold

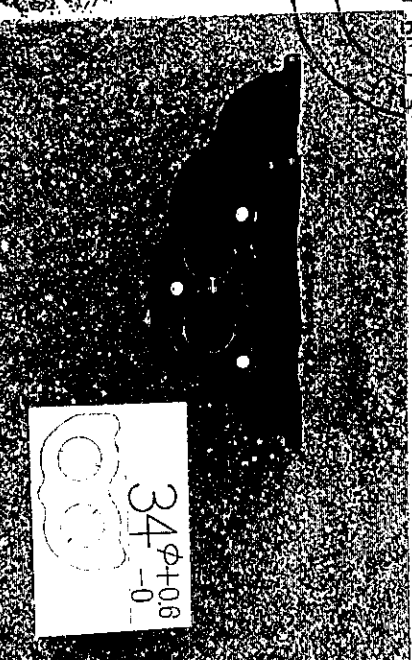

34φ+08  
-0



Make HONDA MOTOR CO., LTD.

Model

HONDA SBI

J.A.F. 公認番号 T-211-V2  
F.I.A. Rec. No. 5531

Serial Number of Chassis and car Weight for HONDA SBI series

(Type of engine & body)

Serial No. of chassis	Engine Capacity	Body type	(9) Car weight
SBA-1007001	1170 cm <sup>3</sup>	2 D	640 kg
SBC-1007002	1170 cm <sup>3</sup>	3 D	655 kg
SBI-1240001	* 1170 cm <sup>3</sup>	2 D	670 kg
"	* 1170 cm <sup>3</sup>	3 D	680 kg

\* 1170 cm<sup>3</sup> = twin carb engine

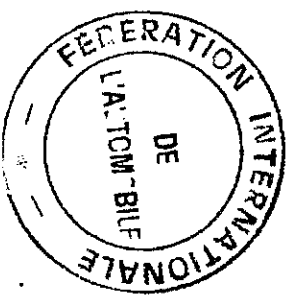



JAPAN AUTOMOBILE FEDERATION  
 社団法人 日本自動車連盟

J.A.F.公認番号 J-211-E3  
 発効年月日 SEP. 30, 1975  
 F.I.A. Homol. No 5531

3/1E

FEDERATION INTERNATIONALE DE L'AUTOMOBILE

Form of recognition accordance with  
 Appendix J to the International Sporting Code.  
 国際スポーツ連盟付則J項及びJAF国内競技車両規則に従った公認書式。

Make HONDA MOTOR CO., LTD. Model HONDA CIVIC SBI  
 製造会社名 型式及び通称名  
 Modification's application starts with serial No. chassis 適用シヤーシー番号 SBI-1240001  
 engine 適用エンジン番号 EB1

Application of this amendment started the OCT. 21, 1974  
 適用年月日 HONDA CIVIC (RS)

The modifications are to be considered as: ~~variant~~ / normal evolution of the type  
 正装進化  
 Date amendment is valid from 1 JANV. 1976 list

Description of amendment 内容

Correction of typing error for HONDA CIVIC (RS)

INLET

181. Diameter of valves	right 36mm	error 35mm
-------------------------	------------	------------

EXHAUST

196. Diameter of valves	right 32mm	error 31mm
-------------------------	------------	------------

Stamp and signature of the JAF

JAF公認印及び署名

難波靖彦  
 Yasuharu Nanba

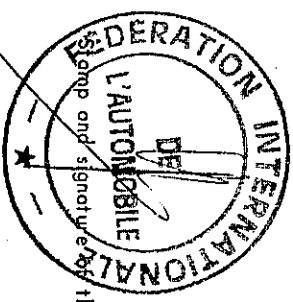

Stamp and signature of the F.I.A.



**JAPAN AUTOMOBILE FEDERATION**  
 社団法人 日本自動車連盟  
 法人

J.A.F.公認番号 T-211 V-4  
 発効年月日 昭和 51年 7月 31日  
 F.I.A. Homol. No 5531  
 4/3V

FEDERATION INTERNATIONALE DE L'AUTOMOBILE

Form of recognition accordance with  
 Appendix J to the International Sporting Code.  
 国際スポーツ法典付則J項及びJAF国内競技車両規則に従った公認形式。

**Make** HONDA MOTOR CO., LTD.  
 製造会社名  
**Modification's** application starts with serial No.

**Model** HONDA CIVIC SBI  
 型式及び通称名  
 chassis 適用シャーシ番号 SBI-1240001, SBA-1007001  
 engine 適用エンジン番号 RB1

Application of this amendment started the **APR 1, 1976**  
 適用年月日  
 Commercial denomination after application of modifications

The modifications are to be considered as: Variant / ~~modification~~ evolution of the type  
 Date amendment is valid from **-1.OCT.1976**  
 型式 / ~~変更~~ 進化  
 List

Description of amendment 内容

Optional

Front disc brake

FRONT

- 53) Number of cylinders per wheel 1
- 54) Bore 51.1 mm
- 58) Width of brake linings 43.5 mm
- 59) Number of pads per brake 2
- 60) Total area per brake 6360 mm<sup>2</sup>

Stamp and signature of the JAF

JAF公認印及び署名

難波靖治

Yasuharu Nanba

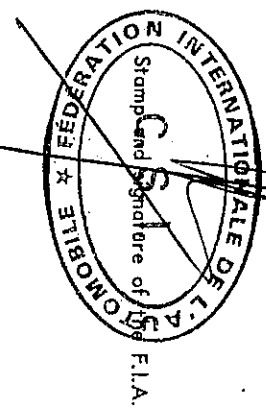



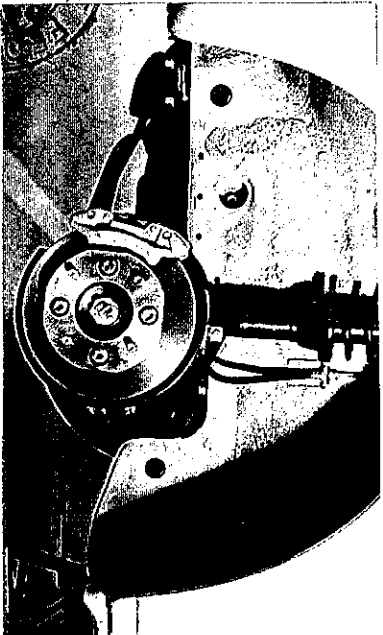

Brake calliper

Parts No.

right 45210-663-6720

left 45230-663-6720

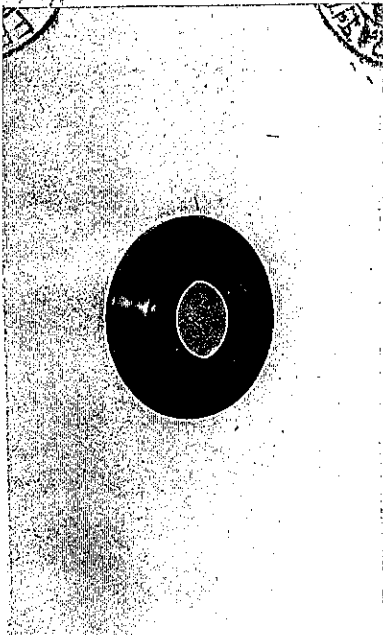

Brake rotor

Parts No.

45251-663-6700

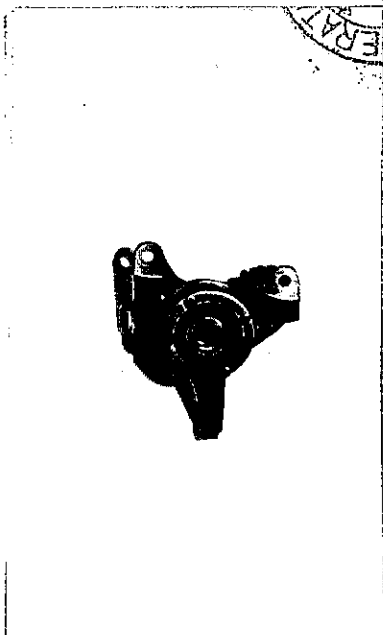

Brake knuckle

Parts No.

right 51211-663-6701

left 51216-663-6701

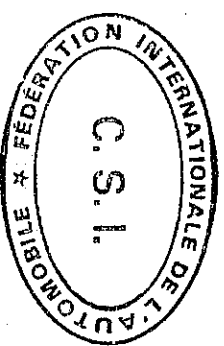



**JAPAN AUTOMOBILE FEDERATION**  
 社団 日本自動車連盟  
 法人

J.A.F.登録番号 T-211-B5  
 発効年月日 OCT. 31, 1970  
 F.I.A. Homol. No 5531

5/2E

FEDERATION INTERNATIONALE DE L'AUTOMOBILE

Form of recognition accordance with  
 Appendix J to the International Sporting Code.  
 国際スポーツ法典付則J項及びJAF国内競技車両規則に従った登録形式。

Make HONDA MOTOR CO., LTD.      Model HONDA CIVIC SBI  
製造会社名      型式及び通称名  
 Modification's application starts with serial No. chassis 適用シアーシー番号 SBA  
適用年月日      適用エンジン番号      EB1  
 Application of this amendment started the NOV. 1, 1972  
 Commercial denomination after application of modifications HONDA CIVIC SBI  
 The modifications are to be considered as: ~~variant~~ / normal evolution of the type  
 Date amendment is valid from -1 JAN. 1977      list

Description of amendment 内容

Revised photograph for F.I.A. Homol. No 5531 (Basic)

Photograph M. Piston crown

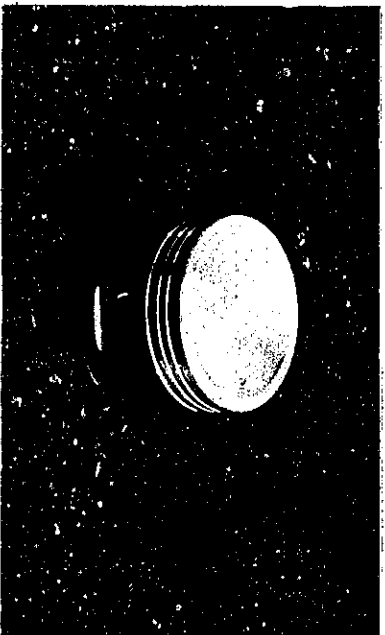

Stamp and signature of the JAF

JAF公認印及び署名

難波靖行

Yasuharu Nanba

